



**Technical Service
BULLETIN**

March 1, 2002

Title:
**2002 MY RAV4 ELECTRIC VEHICLE
PRE-DELIVERY SERVICE (PDS)**

Models:
'02 RAV4-EV

**ELECTRIC VEHICLE
EV001-02**

Introduction This Service Bulletin has been prepared exclusively for Pre-Delivery Service (PDS) on the RAV4 Electric Vehicle (RAV4-EV). While many of the PDS operations are similar to other Toyota vehicles, some operations are specific for the RAV4-EV. Please use the **RAV4-EV** PDS Check Sheet form for Pre-Delivery Service.

PDS is the final step to confirm and insure the delivered vehicle is of the highest quality to satisfy your dealership's new car customer. Customer feedback indicates the following areas deserve special attention when performing PDS:

- Careful inspection for Paint Chips/Scratches and Body Dents/Dings.
- Proper Operation of Electrical Accessories (including interior light, clock, and radio).
- Interior Cleanliness.
- Proper Function of Mechanical Systems.

For improved customer satisfaction, please pay particular attention to the fuse installations, electrical component operations, interior cleanliness, and battery maintenance areas indicated in bold red type.

Precautions The RAV4-EV has unique operating characteristics, so always follow the precautions below when performing the PDS operation:

- The RAV4-EV contains **high voltage** (about 300 volts) AC and DC Systems. All **high voltage** wiring and connections are **orange in color**. Do not touch these **orange colored** wiring harnesses and connectors or the **high voltage** components to which they are attached.
- The inductive charge paddle may get hot after charging. Always use the handle when removing the charge paddle.
- The vehicle is silent when the motor switch is "ON" and the vehicle "READY" light is illuminated. Be sure to place the shift selector in "P," set the parking brake, and remove the motor key unless otherwise instructed.
- The **high voltage** traction battery pack cooling inlet vents are provided on the right and left rear quarter panel. Do not spray high pressure water into these vents or directly on the traction battery pack underneath the vehicle.
- Do not splash water on the electric components in the motor compartment.

**PDS Form
Ordering
Information**

An initial distribution of RAV4-EV PDS forms will be mailed to RAV4-EV participating dealerships. Additional forms may be printed from TIS. Access 2002 RAV4-EV Service Bulletins and search for Attachment: 2002 RAV4-EV PDS Check Sheet under "Product General" (EV001-02).

**Reimbursement
Information**

OP CODE	DESCRIPTION	TIME	OPN	T1	T2
001013	Pre-Delivery Service (PDS)	1.1	N/A	-	-



Warranty Policy If the need for additional repairs or adjustment is noted during PDS, the required service should be performed under warranty. Reimbursement will be managed under the warranty policy.

The Warranty Policy and Procedures Manual requires that you maintain the completed RAV4–EV PDS Check Sheet in the customer’s file. If you cannot produce a completed form for each retailed vehicle upon TMS and/or Region/Distributor audit, the PDS payment amount will be subject to debit.

An additional Repair Order completed in conjunction with normal PDS must have time punch/flags for service. If multiple repairs are performed, separate time flags must be punched for each repair.

2002 Toyota
RAV4 EV PDS
Check Sheet



2002 TOYOTA RAV4 EV PRE-DELIVERY SERVICE CHECK SHEET

A. BEFORE INSPECTION	OK	Adjust/ Repair	E. UNDER VEHICLE (ON HOIST)	OK	Adjust/ Repair
<p>01 INSTALL FUSES <input type="checkbox"/></p> <p style="font-size: small;">Dome, A/C fuses in EV & Motor Room R/B</p>			<p>01 Check transaxle fluid level <input type="checkbox"/> <input type="checkbox"/></p> <p>02 Inspect tires for defects/damage and adjust tire pressure <input type="checkbox"/> <input type="checkbox"/></p> <p>03 Inspect for coolant and other fluid leaks <input type="checkbox"/> <input type="checkbox"/></p> <p>04 Visually check bolts on traction battery for looseness ... <input type="checkbox"/> <input type="checkbox"/></p> <p>05 Install wheel caps <input type="checkbox"/> <input type="checkbox"/></p>		
B. FUNCTIONAL OPERATION			F. ROAD TEST		
Apply parking brake, turn motor switch "ON", ("READY" is off) turn on headlights and rear defogger and unlock doors.			A complete road test helps assure Customer Satisfaction. Drive vehicle over a variety of road surfaces and driving conditions. Check for unusual noises and vehicle performance.		
<p>01 Check dome/map lights <input type="checkbox"/> <input type="checkbox"/></p> <p>02 Check warning/indicator lights, gauges, and horn <input type="checkbox"/> <input type="checkbox"/></p> <p>03 Check windshield wipers and washers <input type="checkbox"/> <input type="checkbox"/></p> <p>04 Check headlights, instrument lights, turn signals, emergency flashers, and brake lights <input type="checkbox"/> <input type="checkbox"/></p> <p>05 Check inside/outside rear view mirror operation/adjustment <input type="checkbox"/> <input type="checkbox"/></p> <p>06 Check cigarette lighter <input type="checkbox"/> <input type="checkbox"/></p> <p>07 Check audio system and set clock <input type="checkbox"/> <input type="checkbox"/></p> <p>08 Check seat heater operation <input type="checkbox"/> <input type="checkbox"/></p> <p>09 Install shift-lock override button cover <input type="checkbox"/> <input type="checkbox"/></p>			<p>Enter Odometer Reading</p> <p>Reading Before Test _____</p> <p>Reading After Test _____</p>		
C. WALKAROUND INSPECTION			G. FINAL INSPECTION AND CLEANING		
Start at left front door. Check window and door lock operation (from master power switch, if equipped). Continue around vehicle in a counterclockwise direction checking each door and window operation, child door locks, seat belts, interior condition, all lights, trunk contents. Finish by checking headlight aim and continue into UNDER HOOD checks.			01 Check motor operation <input type="checkbox"/> <input type="checkbox"/>		
<p>01 Check window operation <input type="checkbox"/> <input type="checkbox"/></p> <p>02 Check door and door lock operation <input type="checkbox"/> <input type="checkbox"/></p> <p>03 Check that the vehicle starts (READY is illuminated) with all keys <input type="checkbox"/> <input type="checkbox"/></p> <p>04 Check heated windshield (HWS) operation <input type="checkbox"/> <input type="checkbox"/></p> <p>05 Check that child safety door locks are in normal (unlocked) position <input type="checkbox"/> <input type="checkbox"/></p> <p>06 Check seats and seat belt operation <input type="checkbox"/> <input type="checkbox"/></p> <p>07 Check rear defogger <input type="checkbox"/> <input type="checkbox"/></p> <p>08 Check side marker, tail, backup, and license plate lights <input type="checkbox"/> <input type="checkbox"/></p> <p>09 Check cargo light and cargo trim appearance <input type="checkbox"/> <input type="checkbox"/></p> <p>10 Check spare tire pressure and jack/tool installation <input type="checkbox"/> <input type="checkbox"/></p> <p>11 Check charge port inlet <input type="checkbox"/> <input type="checkbox"/></p> <p>12 Check headlight aim <input type="checkbox"/> <input type="checkbox"/></p>			<p>02 Check shift selector operation & EB switch operation ... <input type="checkbox"/> <input type="checkbox"/></p> <p>03 Check brake and parking brake operation <input type="checkbox"/> <input type="checkbox"/></p> <p>04 Check steering operation and off-center/vehicle pull/flutter <input type="checkbox"/> <input type="checkbox"/></p> <p>05 Inspect for abnormal noises and vibration <input type="checkbox"/> <input type="checkbox"/></p> <p>06 Inspect for squeaks and rattles <input type="checkbox"/> <input type="checkbox"/></p> <p>07 Check A/C and heater operation <input type="checkbox"/> <input type="checkbox"/></p>		
D. UNDER HOOD			COMMENTS		
<p>01 Check brake and power steering fluid levels <input type="checkbox"/> <input type="checkbox"/></p> <p>02 Check radiator coolant level <input type="checkbox"/> <input type="checkbox"/></p> <p>03 Check windshield washer fluid level <input type="checkbox"/> <input type="checkbox"/></p> <p>04 Check auxiliary battery state-of-charge by Open Circuit Voltage method. Recharge if below 12.4 volts (75% charge) <input type="checkbox"/> <input type="checkbox"/></p> <p>05 Inspect for coolant and other fluid leaks <input type="checkbox"/> <input type="checkbox"/></p>			_____ _____ _____ _____ _____		
Completion and retention of this form is required to comply with Toyota's Warranty Policy.					
_____ TECHNICIAN'S SIGNATURE		_____ SERVICE MANAGER'S SIGNATURE		<p style="color: red; font-weight: bold;">We hereby certify that all items on this form have been checked and corrected for proper operation as required.</p>	
_____ NAME (PLEASE PRINT)		_____ NAME (PLEASE PRINT)			
Date	Dealer Name	Dealer Code	Vehicle Identification Number (Sticker)		

M/N 00406-PDS02-RAVEV

Before Inspection

When performing new car Pre-Delivery Service, install fuses before moving the vehicle from the storage lot so that FUNCTIONAL OPERATION checks can begin as soon as the vehicle is moved into the service stall.

A01. Install fuses

Remove 10A fuses from the EV and Motor Room Relay Blocks, and install in the Dome and A/C positions as shown below.

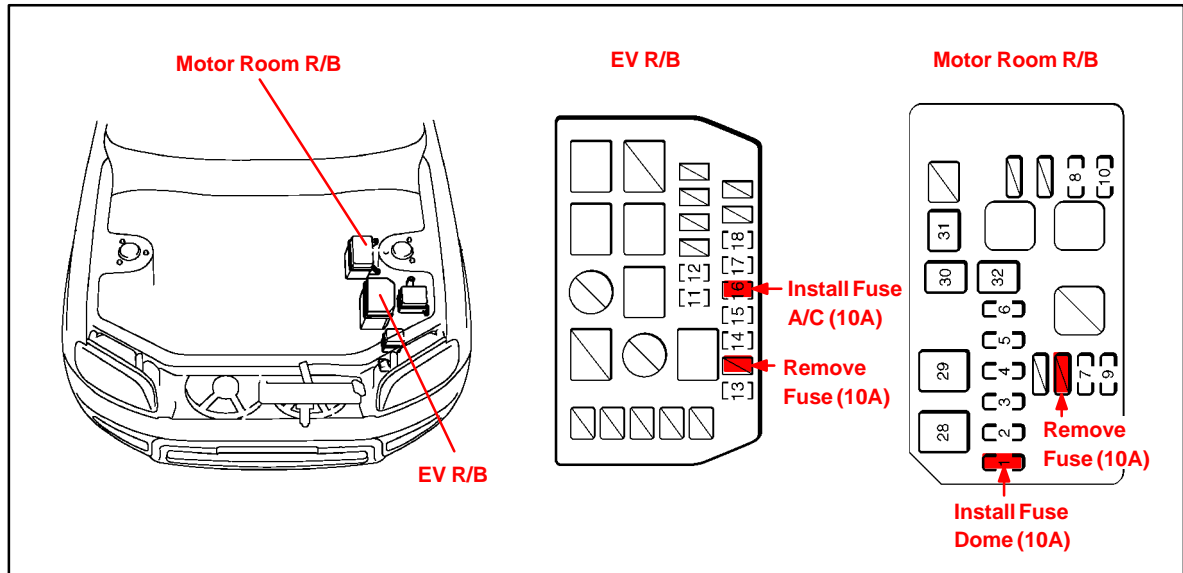
**Functional Operation**

Apply the parking brake, turn the motor switch "ON" (Do not start the vehicle – "READY" is off); turn on headlights and rear defogger and unlock all doors.

B01. Check dome/map lights**NOTE:**









Insure that the dome light operates in the "OFF" and "DOOR" switch positions. Also check the dome light operates after depressing the left and right dome light buttons.

B02. Check warning/indicator lights, gauges, and horn

(See the following page for warning light descriptions)

B03. Check windshield wipers and washers**B04. Check headlights, instrument lights, turn signals, emergency flashers, and brake lights****B05. Check inside/outside rear view mirror operation/adjustment****B06. Check cigarette lighter****B07. Check audio system and set clock****B08. Check seat heater operation****B09. Install the shift-lock override button cover**

Functional Operation
(Continued)

WARNING LIGHTS & BUZZERS (In Speedometer Cluster)		FUNCTION
BRAKE	Brake System Warning Light & Buzzer	<ul style="list-style-type: none"> • Parking Brake Reminder This light comes on when the parking brake is applied. • Low Brake Fluid Level Warning • Brake System Warning This light warns that there is a problem somewhere in the brake system. If the brake system fails seriously, the warning buzzer also may sound.
	SRS Airbag Warning Light	This light comes on when the motor switch is turned to "ACC" or "ON." It goes off after a few seconds. This means the SRS airbag system is operating properly.
	Seat Belt Reminder Light & Buzzer	Once the motor switch is turned to "ON" or "START," the reminder light flashes and buzzer sounds if the driver's seat belt is not fastened. Unless the driver fastens the belt, the light stays flashing and the buzzer stops after 4–8 seconds.
	Open Door Warning Light	This light remains on until all the doors are completely closed.
	Low Tire Pressure Warning Light	The light comes on when the motor switch is turned to "ON" position. It goes off after about 3 seconds.
	SOC (State-of-Charge) Warning Light	This light comes on when the charging capacity is less than about 20%, and blinks when the charging capacity is less than about 15%.
ABS	ABS Warning Light	This light comes on when the motor switch is turned to "ON" and goes off after a few seconds.
	Auxiliary Battery Discharge Warning Light	This light comes on if the auxiliary battery charging system fails.
	Output Control Warning Light and Buzzer	<ul style="list-style-type: none"> • This light comes on if the traction motor or motor inverter is overheated or the traction battery temperature is too low or too high. • If the maximum torque of traction motor drops more than 50% the buzzer sounds after the warning light comes on.
	Motor System Caution Light	This light comes on if the motor system fails.
	Key Reminder Buzzer	This buzzer reminds you to remove the key when you open the driver's door with the motor key in the "ACC" or "LOCK" position.
	Light Reminder Buzzer	This buzzer will sound if the driver's door is opened with the key removed from the motor switch and the headlight switch left on.
	Shift Position Reminder Buzzer	This buzzer sounds when the driver's door is opened with the shift selector in a position other than "P" and the "READY" light on.

* Brake System warning and ABS warning lights may stay on for about 60 seconds after the traction motor is started. It is normal if they go out after a while. When the brake pedal is depressed repeatedly, the brake system warning and ABS warning lights may come on and the buzzer sounds. It is normal if the lights go out and the buzzer stops sounding after a few seconds.

Walkaround Inspection

Starting at left front door, check window and door lock operation and the operation of all power windows and door locks from the master switch. While walking around the vehicle in a counterclockwise direction, open the left rear door and check operation of the power window and door lock, set the child safety door lock to the normal unlocked position. Assure tightness of interior garnishes and check seat belts. Inspect cargo contents and lights at rear of vehicle. Repeat checks at right rear door. Inspect right front power window, lock operation, and interior trim garnishes. Check seats and seat belt operation. Continue on around to the front of the vehicle to check the lights.

C01. Check window operation**C02. Check door and door lock operation****C03. Check that the vehicle starts with all keys (“READY” is illuminated)**

Insure the shift selector is in “P,” depress the brake pedal, and then turn the motor switch to “START.” The vehicle has started once the “READY” indicator is illuminated in the combination meter and a beep sounds.

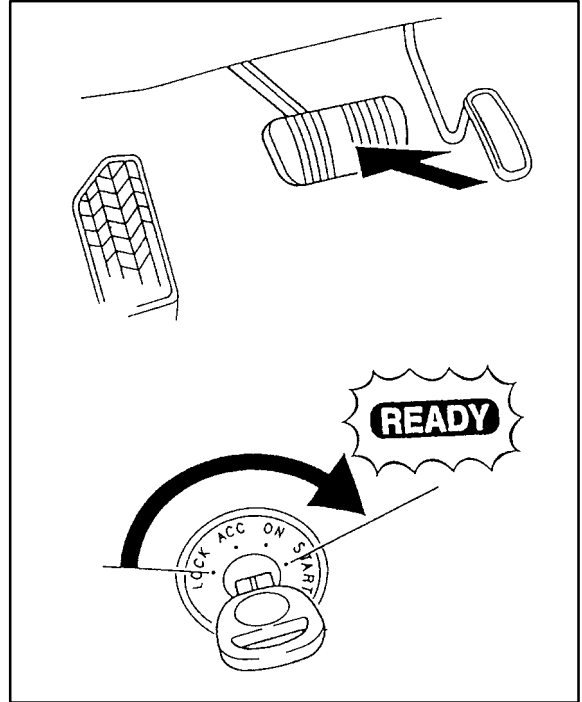
**C04. Check heated windshield (HWS) operation**

With the “READY” indicator illuminated, push the HWS switch and insure the indicator light comes on. Check the front windshield heats up as shown in the illustration. Turn the motor switch to “LOCK” and then to “ON” (“READY” is off) and continue with walkaround inspection.

NOTE:

When the outside temperature is more than approximately 86°F, the heated windshield does NOT operate even with the switch pushed in.

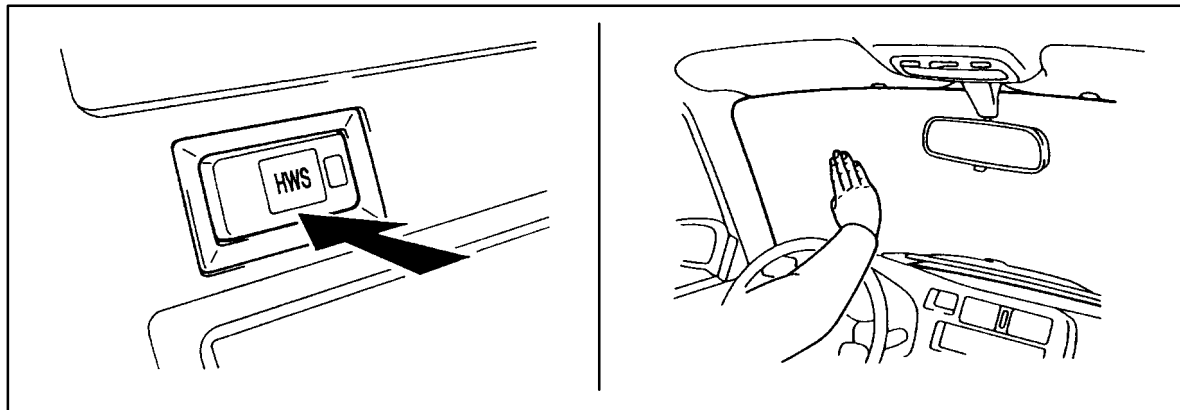

**Walkaround
Inspection**
(Continued)**C05. Check that child safety door locks are in normal (unlocked) position****C06. Check seats and seat belt operation****C07. Check rear defogger****C08. Check side marker, tail, backup, and license plate lights****NOTE:**

When checking the backup lights, apply the parking brake, insure the motor switch is in the "ON" position ("READY" is off) and move the shift selector to "R." Have an assistant verify the reverse light operations, then shift the selector to "P."

C09. Check cargo light and cargo trim appearance**C10. Check spare tire pressure and jack/tool installation**

Spare tire pressure is 60 psi.

C11. Check charge port inlet

Push the charge port door release button on the charge control panel as shown in the illustration.

Check that the charge port door opens smoothly.

Insert the charge paddle into the charge port and check for normal fit.

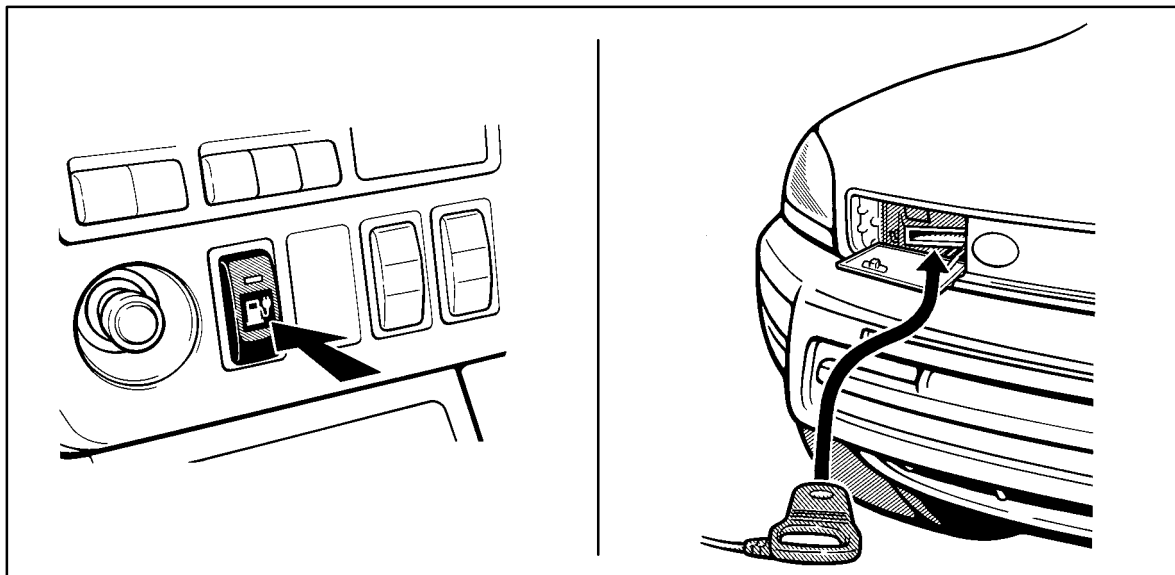
**C12. Check headlight aim**

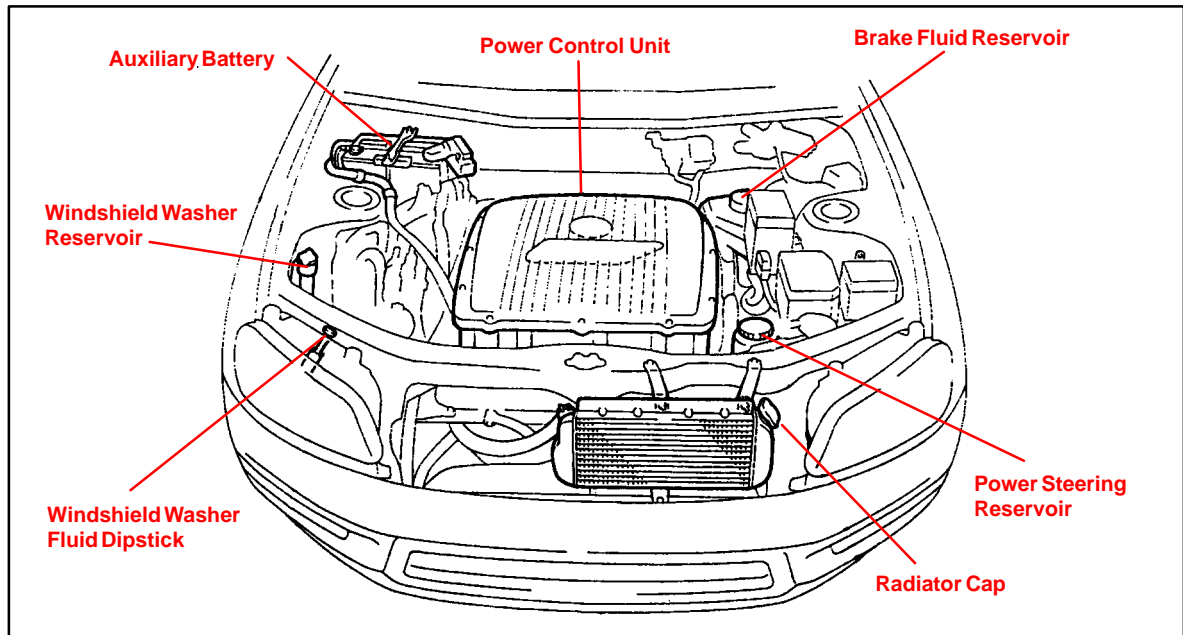
Under Hood

D01. Check brake and power steering fluid levels

D02. Check radiator coolant level

CAUTION:

Do NOT remove the radiator cap if the radiator is hot.

NOTE:

The coolant level in the reservoir will vary with coolant temperature.

D03. Check windshield washer fluid level

D04. Check auxiliary battery state-of-charge by open circuit voltage method
Recharge if below 12.4 volts (75% state-of-charge)

D05. Inspect for coolant and other fluid leaks

**Under Vehicle
(On Hoist)**

Hoist the vehicle securely by the lift points shown in the illustration below.

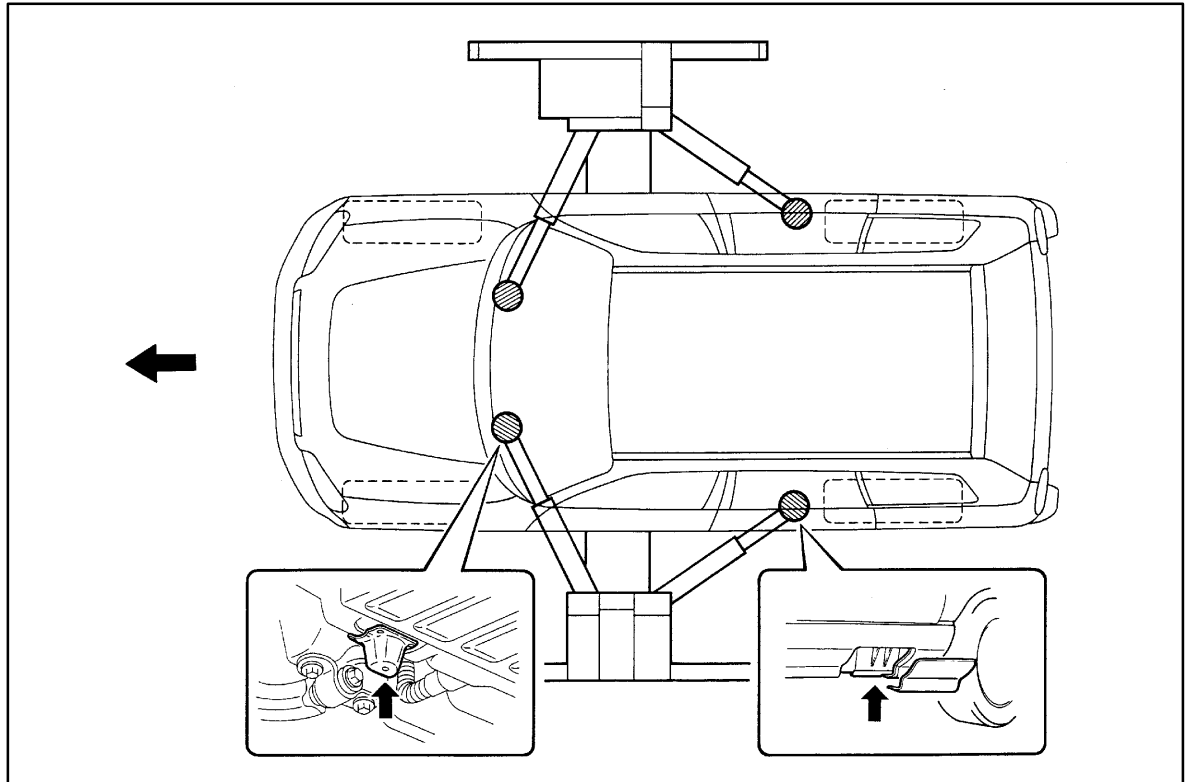

E01. Check transaxle fluid level

Remove the fill plug and check fluid level is 5 mm or less from the bottom of the fill hole as shown. If necessary, add Dexron II or III ATF. Retorque the fill plug to 40 ft•lbs.

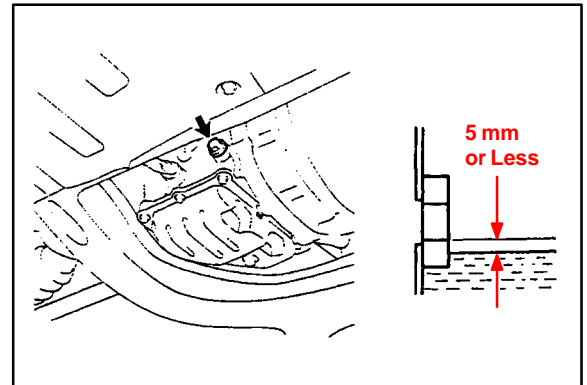

E02. Inspect tires for defects/damage and adjust tire pressure

Tire pressure is 44 psi.

E03. Inspect for coolant and other fluid leaks

E04. Visually check bolts on traction battery for looseness

Inspect 16 bolts indicated by the black dots shown in the illustration. Bolt torque is 43 ft•lbs.

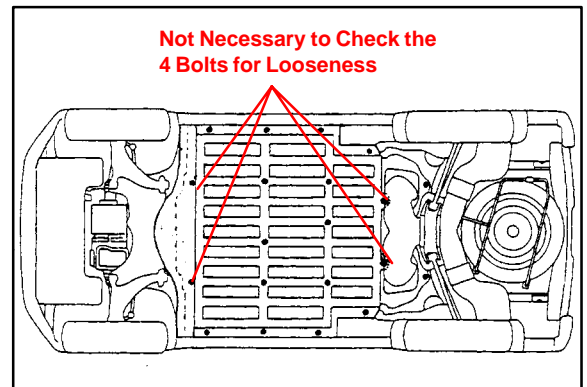

E05. Install wheel caps

Road Test A complete road test helps assure customer satisfaction. Drive the vehicle over a variety of road surfaces and driving conditions. Check for unusual noises and vehicle performance.

F01. Check motor operation

Start vehicle and insure the “READY” indicator illuminates.

F02. Check shift selector operation & EB switch operation

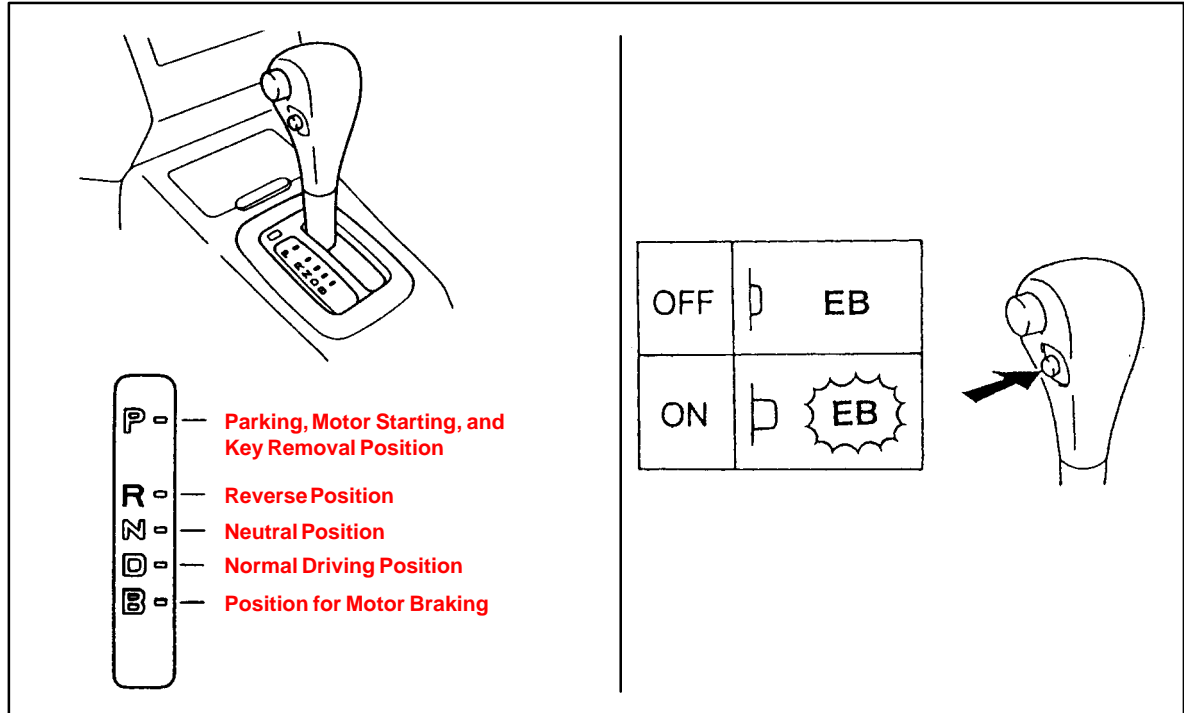

F03. Check brake and parking brake operation

F04. Check steering operation and off-center/vehicle pull/flutter

F05. Inspect for abnormal noises and vibration

F06. Inspect for squeaks and rattles

F07. Check A/C and heater operation

**Final
Inspection
& Cleaning**

G01. Remove interior protective covers, unnecessary labels, tags, etc.

(Remove protective covers just before delivery to customer).

- Remove plastic covers from door panels, seats, head restraints, and sun visors, as required.
- Remove labels, tags, and stickers (except those containing owner information).

NOTE:

Customer information labels such as the air bag warnings and bumper information labels must be left on the vehicle until delivery to a retail customer.

G02. Visually inspect all interior parts for installation, damage, fit, dirt, etc.

G03. Remove Rappgard™ protective film

Final
Inspection
& Cleaning
(Continued)

G04. Wash and clean vehicle

NOTE:

Do NOT spray high pressure water into the battery pack inlet vents or directly on the traction battery pack underneath the vehicle.

G05. Inspect paint finish for scratches, chips, rust, dents, damage, etc.

G06. Inspect exterior body parts for proper installation, damage, rust, etc.

G07. Recharge traction battery

Charge the traction battery using the charging system until it automatically stops.

Verify the SOC meter indicates "F" (Full Charge) when the motor key is switched "ON" as shown.

NOTE:

After the completion of the charge, the SOC meter may drop from "F" due to shelf discharge in the battery pack.

